



HCEM • 浙江鸿川动力

HONGCHUAN POWER TECHNOLOGY CO.,LTD



DC Air Compressor

Company Introduction



Zhejiang Hongchuan Power Technology Co.,Ltd was first established in 2010,which is a large-scale enterprise group, specializing in R&D and manufacturing various kinds of air compressors and vacuum pumps .We have 20+ engineers with more than 10 years experience ,from the structural design, appearance design and mold development all can be done by our own R&D team.

Our products mainly serve industries such as medical equipment,dental equipment,robotic arms,automation equipment,beauty equipment,packaging equipment,new energy vehicles and pond aeration systems etc .

Dedicated to strict quality control and thoughtful customer service,our experienced engineers are always available to discuss your requirements and ensure full customer satisfaction.

Our main markets include the USA,Mexico,Germany, Japan ,UK,Italy,Spain,Australia,Russia,Indonesia and South Korea etc. We welcome the OEM and ODM orders.

Whether selecting a current product from our catalog or seeking engineering assistance for your application,you can talk to our customer service center about your sourcing requirements.

Adhering to the business principle of mutual benefits,we have had a reliable reputation among our customers because of our professional services,quality products and competitive prices , looking forward to your collaboration .



**Air Compressor Solutions Backed
by 20 Years of Global Success.**

Trusted by 8,000+ Clients Worldwide.

application



Solar aerator



Oxygen machine



Electric Vehicle



Sewage treatment



Mast



Industrial compressor



Biology system



Laboratory and medical

DC Oil Free Air Compressor

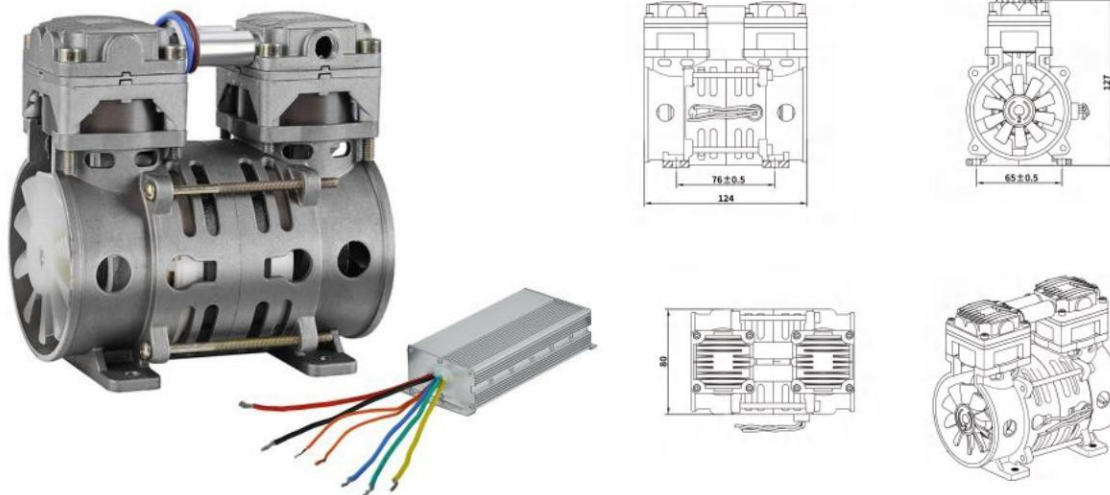

Technical Specification

Model Number	HC80C-17/1.4	HC80D-17/1.4	HC80E-17/1.4
Voltage	DC12V	DC24V	DC48V
Current at rated pressure	7.5A	3.75A	1.87A
Power at rated pressure	≤90W	≤90W	≤90W
Air flow rate at rated pressure	17L/min@140Kpa	17L/min@140Kpa	17L/min@140Kpa
Dimension	124*80*127mm	124*80*127mm	124*80*127mm
Installation size	75*65mm	75*65mm	75*65mm
Rated speed	1700rpm	1700rpm	1700rpm
Net weight	1.5kg	1.5kg	1.5kg
Noise	≤48dB(A)	≤48dB(A)	≤48dB(A)

Feature:

Oil free operation (maintenance free)

Low vibration & noise

DC Brushless Motor

Imported consumable parts

24 hours continuous & stable output

DC Oil Free Air Compressor

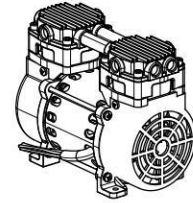
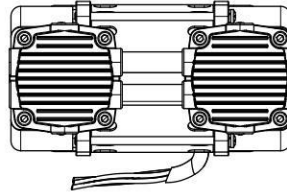
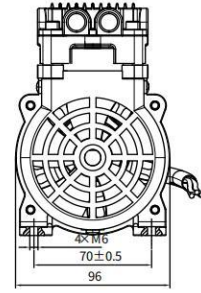
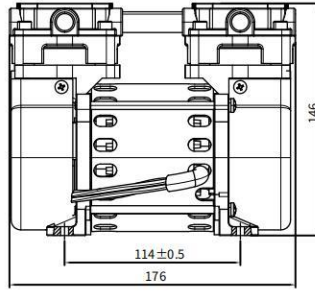

Technical Specification

Model	HC100C-9/7	HC100D-9/7	HC100E-9/7
Voltage	DC12V	DC24V	DC48V
Current at rated pressure	16.7 A	8.3 A	4.17 A
Power at rated pressure	≤200W	≤200W	≤200W
Air flow rate at rated pressure	9L/min @700Kpa	9L/min @700Kpa	9L/min @700Kpa
Dimension	176*96*146 mm	176*96*146 mm	176*96*146 mm
Installation size	70*114 mm(4xM6)	70*114 mm(4xM6)	70*114 mm(4xM6)
Rated speed	1700rpm	1700rpm	1700rpm
Net weight	2.45 kg	2.45 kg	2.45 kg

Performance Chart - Flow VS. Pressure

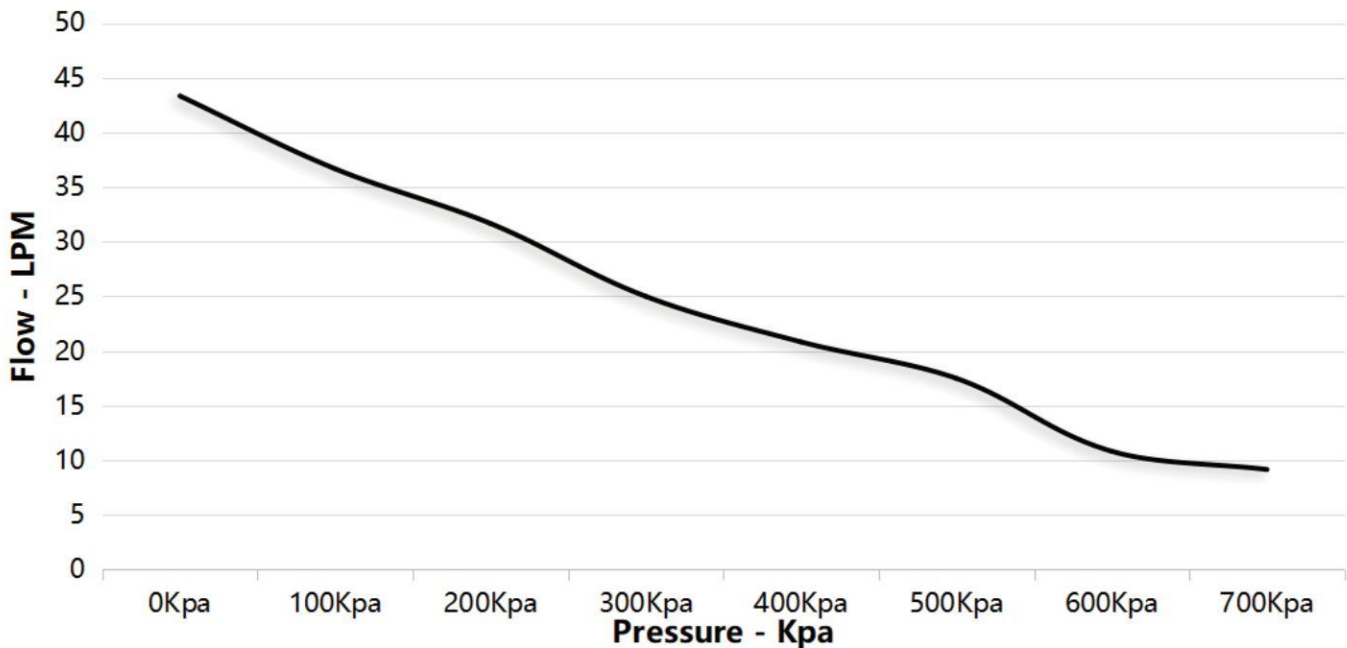

DC Oil Free Air Compressor

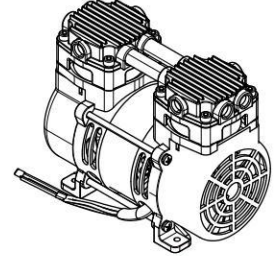
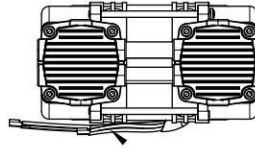
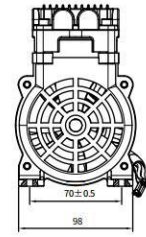
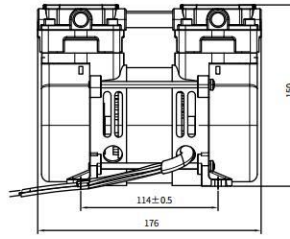
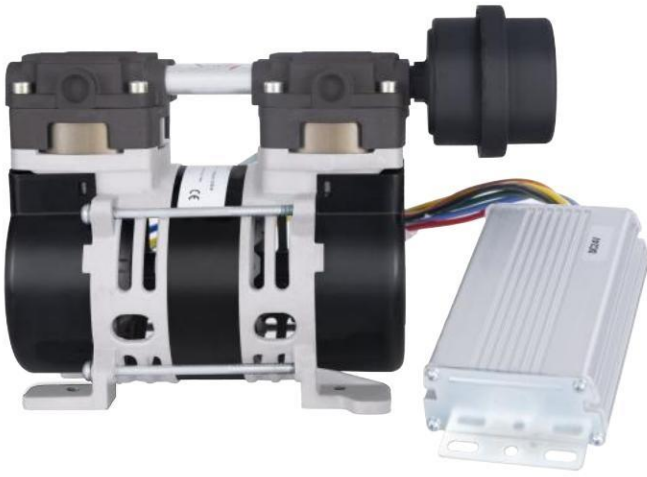

Technical Specification

Model	HC210C-11/7	HC210D-11/7	HC210E-11/7
Voltage	12V	24V	48V
Current at rated pressure	17.5A	8.75A	4.38A
Power at rated pressure	≤210W	≤210W	≤210W
Air flow rate at rated pressure	11 L/min @ 700Kpa	11 L/min @ 700Kpa	11 L/min @ 700Kpa
Dimension	177*98*150 mm	177*98*150 mm	177*98*150 mm
Installation size	70*114 mm(4xM6)	70*114 mm(4xM6)	70*114 mm(4xM6)
Rated speed	1700rpm	1700rpm	1700rpm
Net weight	3 kg	3 kg	3 kg
Noise	≤61dB(A)	≤61dB(A)	≤61dB(A)

Performance Chart - Flow VS. Pressure

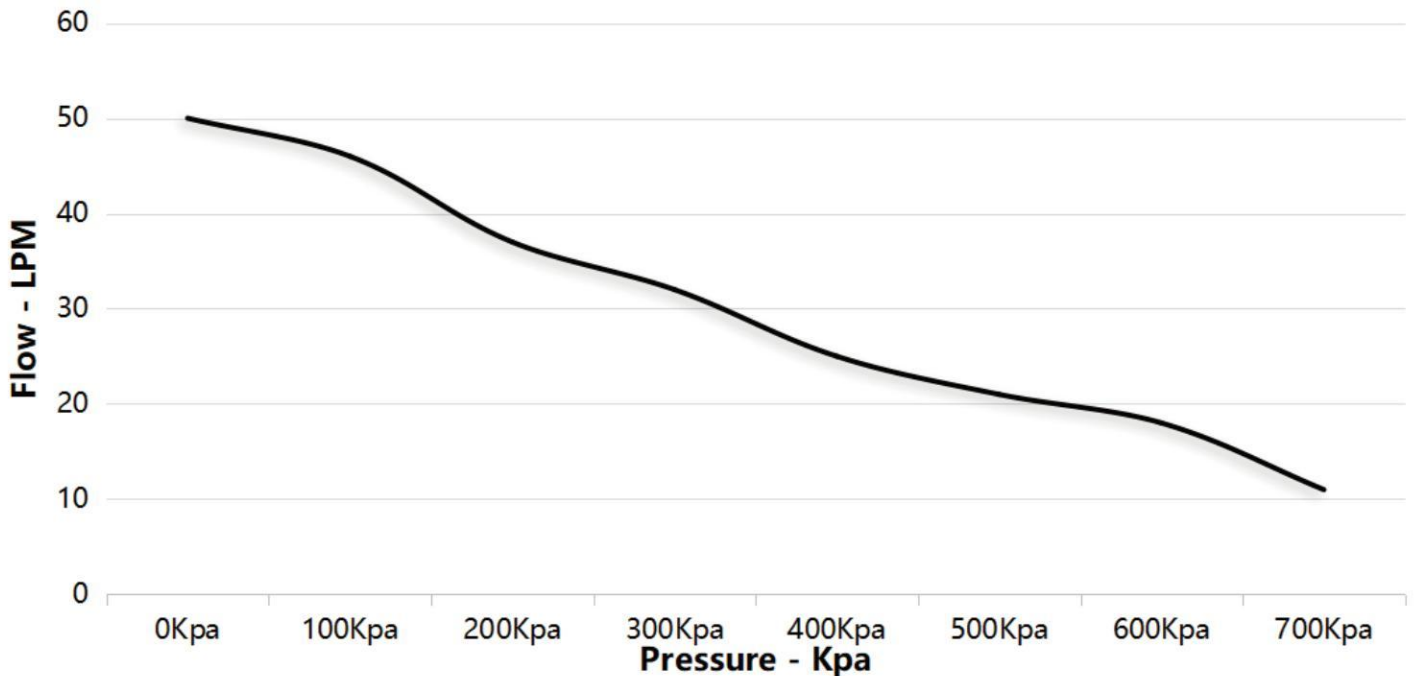

DC Oil Free Air Compressor

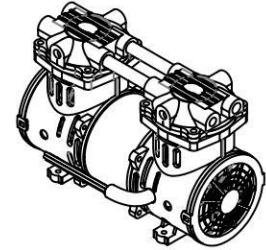
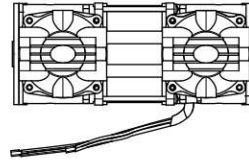
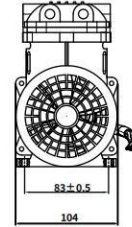
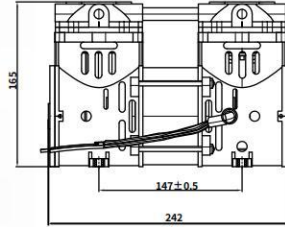

Technical Specification

Model	HC280C-25/7	HC280D-25/7	HC280E-25/7
Voltage	DC12V	DC24V	DC48V
Current at rated pressure	30.8 A	15.4 A	7.7A
Power at rated pressure	≤370W	≤370W	≤370W
Air flow rate at rated pressure	25L/min @ 700Kpa	25L/min @ 700Kpa	25L/min @ 700Kpa
Dimension	242*104*165 mm	242*104*165 mm	242*104*165 mm
Installation size	83*147 mm(4xM6)	83*147 mm(4xM6)	83*147 mm(4xM6)
Rated speed	1700rpm	1700rpm	1700rpm
Net weight	6.0 kg	6.0 kg	6.0 kg
Noise	≤62dB(A)	≤62dB(A)	≤62dB(A)

Performance Chart - Flow VS. Pressure

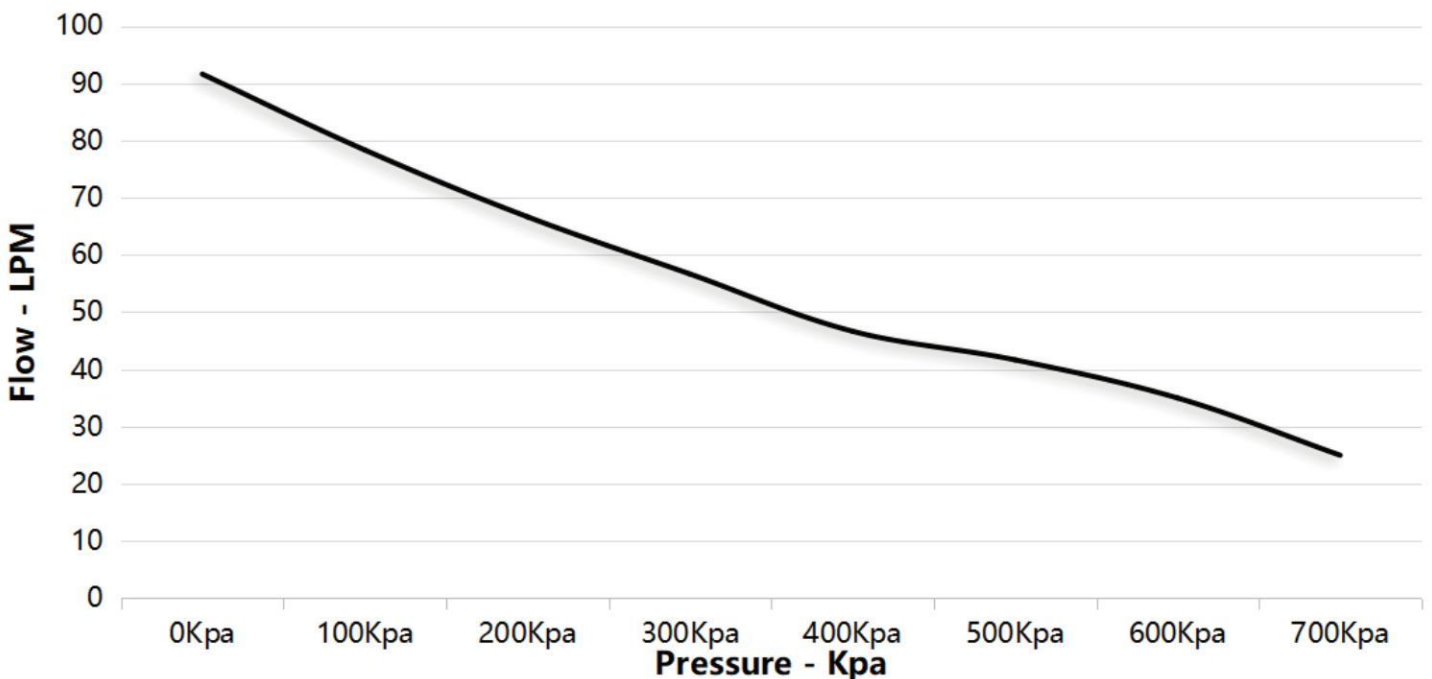

DC Oil Free Air Compressor

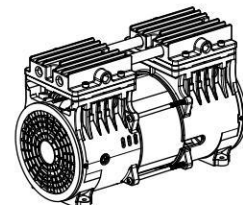
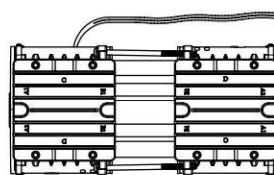
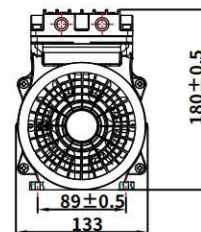
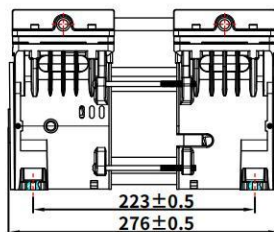
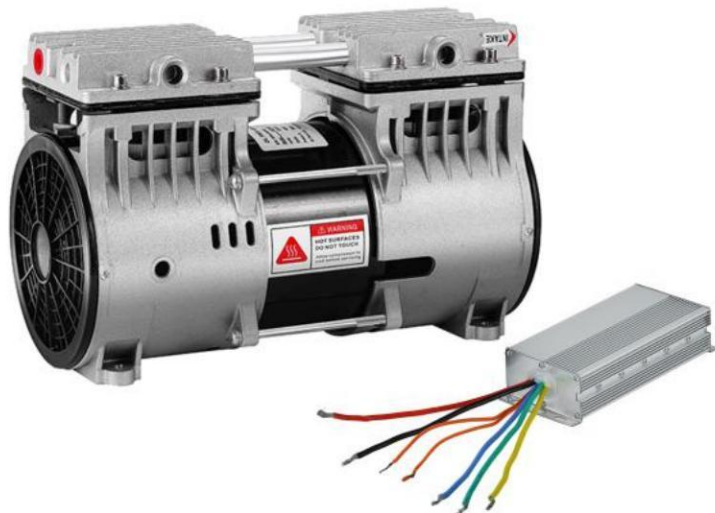

Technical Specification

Model	HC480C-45/7	HC480D-45/7	HC480E-45/7
Voltage	DC12V	DC24V	DC48V
Current at rated pressure	46.66 A	23.33 A	11.66 A
Power at rated pressure	≤560W	≤560W	≤560W
Air flow rate at rated pressure	45 L/min @ 700Kpa	45 L/min @ 700Kpa	45 L/min @ 700Kpa
Dimension	276*133*180 mm	276*133*180 mm	276*133*180 mm
Installation size	89*223 mm(4xM6)	89*223 mm(4xM6)	89*223 mm(4xM6)
Rated speed	1700rpm	1700rpm	1700rpm
Net weight	7 kg	7 kg	7 kg
Noise	≤65dB(A)	≤65dB(A)	≤65dB(A)

Performance Chart - Flow VS. Pressure

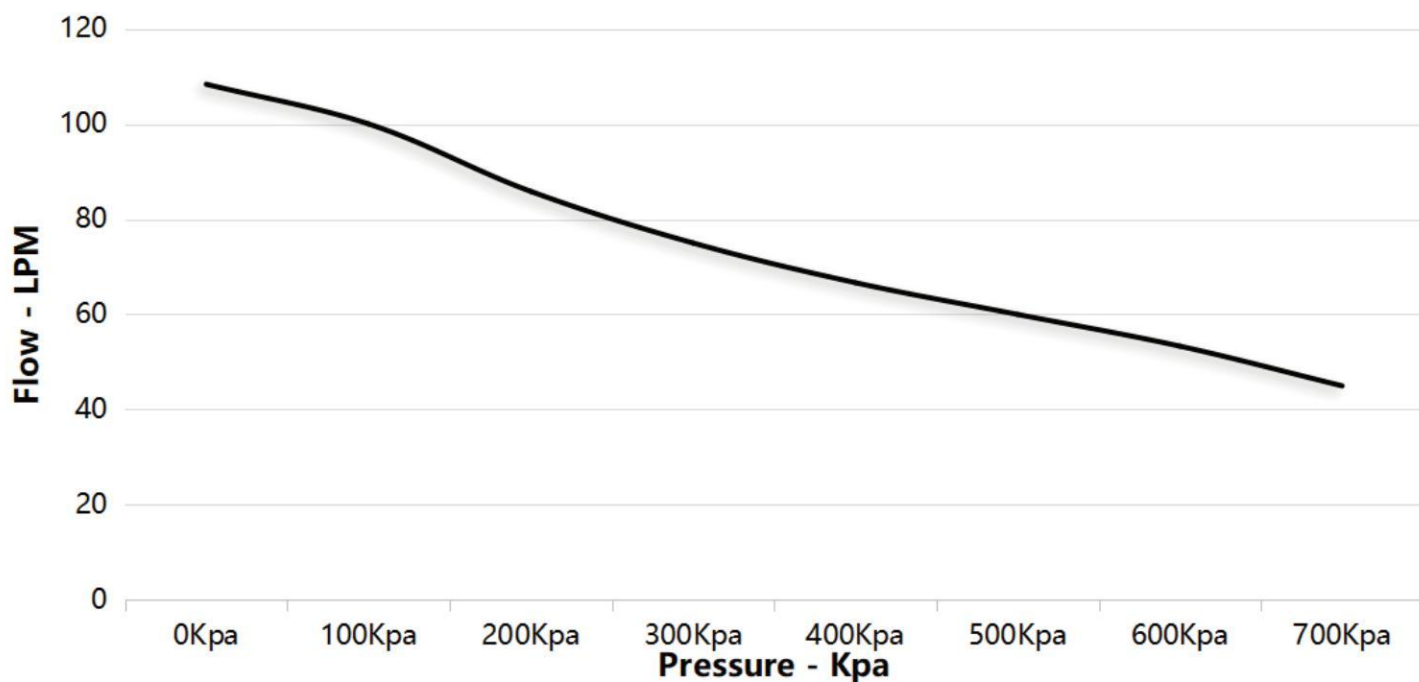

DC Oil Free Air Compressor

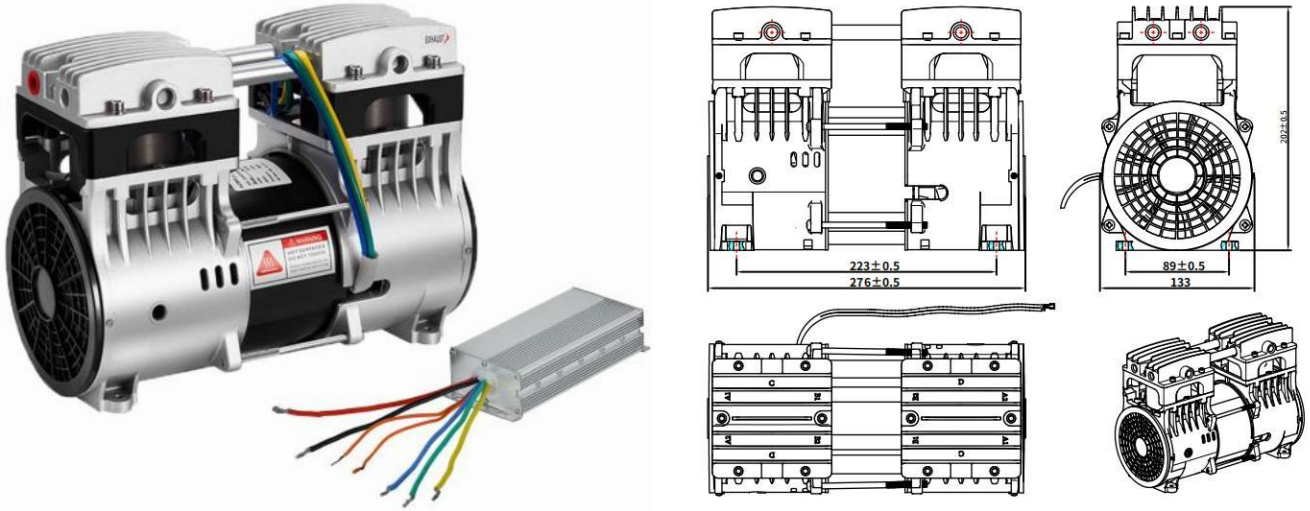

Technical Specification

Model	HC580C-60/7	HC580D-60/7	HC580E-60/7
Voltage	DC12V	DC24V	DC48V
Current at rated pressure	57.5 A	28.7 A	14.3 A
Power at rated pressure	≤690W	≤690W	≤690W
Air flow rate at rated pressure	60 L/min @ 700Kpa	60 L/min @ 700Kpa	60 L/min @ 700Kpa
Dimension	276*133*202 mm	276*133*202 mm	276*133*202 mm
Installation size	89*223 mm(4xM6)	89*223 mm(4xM6)	89*223 mm(4xM6)
Rated speed	1700rpm	1700rpm	1700rpm
Net weight	7.3 kg	7.3 kg	7.3 kg
Noise	≤65dB(A)	≤65dB(A)	≤65dB(A)

Performance Chart - Flow VS. Pressure

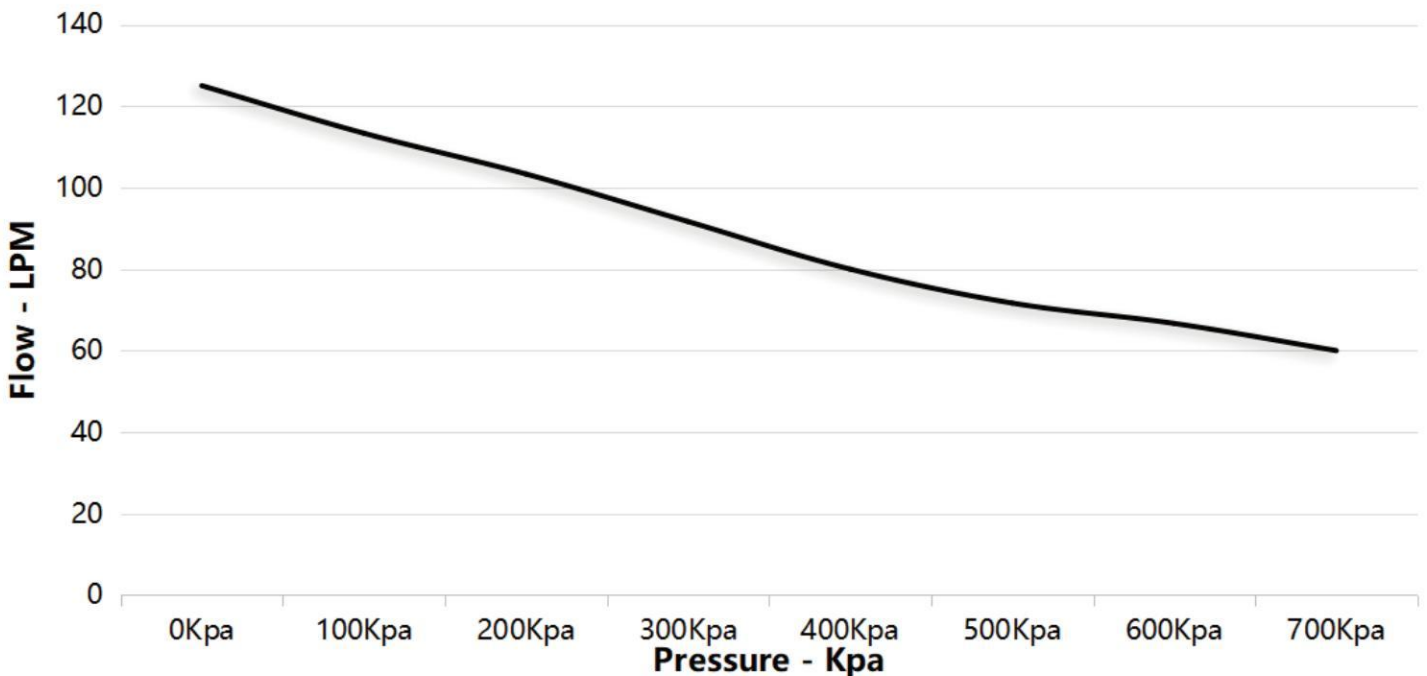

DC Oil Free Air Compressor

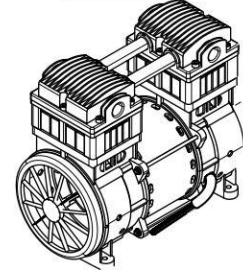
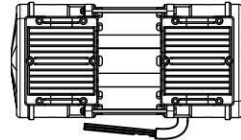
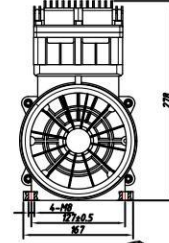
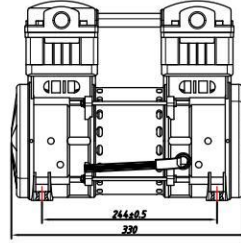

Technical Specification

Model	HC1100D-100/8	HC1100E-100/8	HC1100F-100/8
Voltage	DC24V	DC48V	DC144V
Current at rated pressure	45.8A	22.9A	7.6A
Power at rated pressure	≤1100W	≤1100W	≤1100W
Air flow rate at rated pressure	100 L/min @ 800Kpa	100 L/min @ 800Kpa	100 L/min @ 800Kpa
Dimension	330*167*278 mm	330*167*278 mm	330*167*278 mm
Installation size	127*244 mm (4xM8)	127*244 mm (4xM8)	127*244 mm (4xM8)
Rated speed	1700rpm	1700rpm	1700rpm
Net weight	12.6 kg	12.6 kg	12.6 kg
Noise	≤68dB(A)	≤68dB(A)	≤68dB(A)

Performance Chart - Flow VS. Pressure

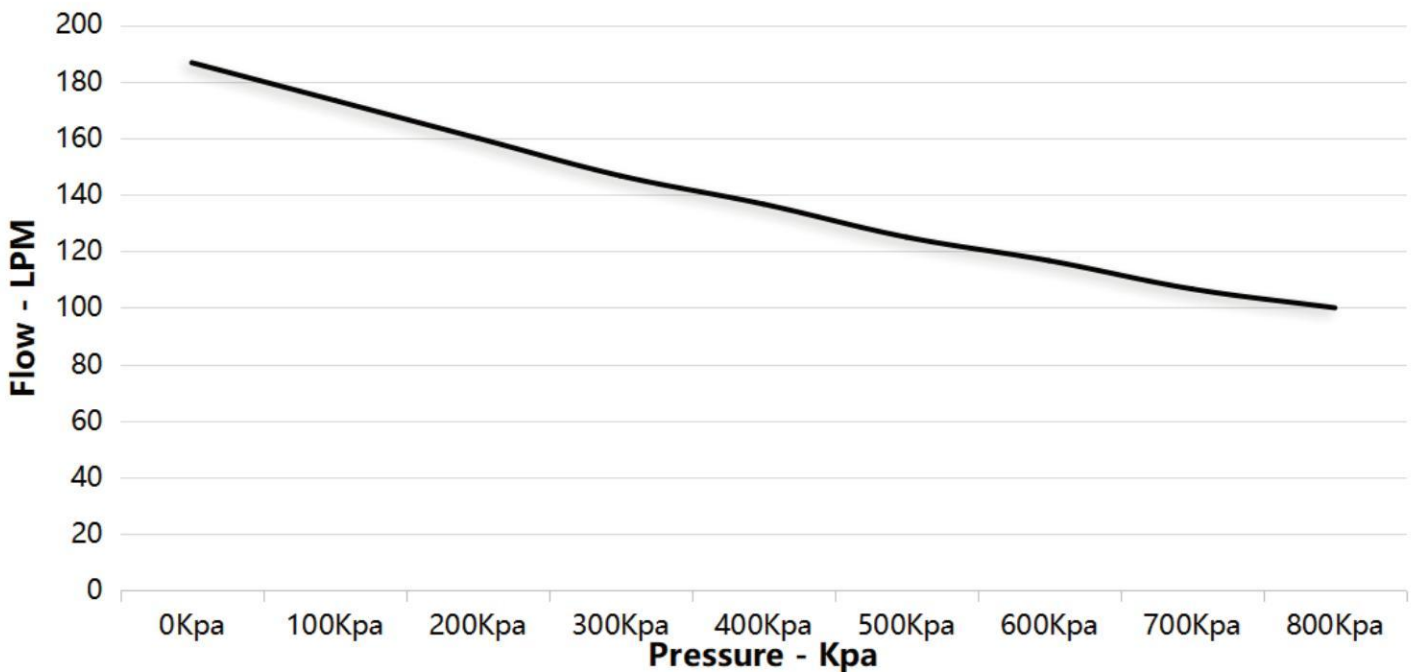

DC Oil Free Air Compressor

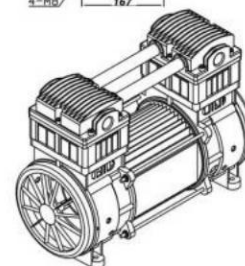
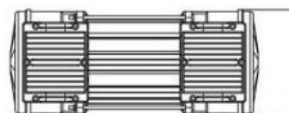
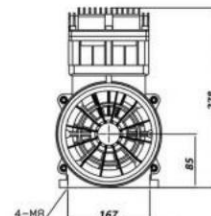
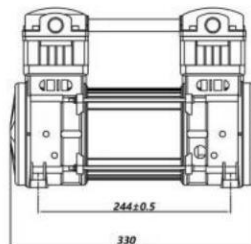

Technical Specification

Model	HC1500D-120/8	HC1500E-120/8	HC1500F-120/8
Voltage	DC24V	DC48V	DC144V
Current at rated pressure	62.5 A	31.2 A	10.4 A
Power at rated pressure	≤1500W	≤1500W	≤1500W
Air flow rate at rated pressure	120 L/min @ 800Kpa	120 L/min @ 800Kpa	120 L/min @ 800Kpa
Dimension	330*167*278 mm	330*167*278 mm	330*167*278 mm
Installation size	127*244 mm (4xM8)	127*244 mm (4xM8)	127*244 mm (4xM8)
Rated speed	1700rpm	1700rpm	1700rpm
Net weight	12.6 kg	12.6 kg	12.6 kg
Noise	≤68dB(A)	≤68dB(A)	≤68dB(A)

Performance Chart - Flow VS. Pressure

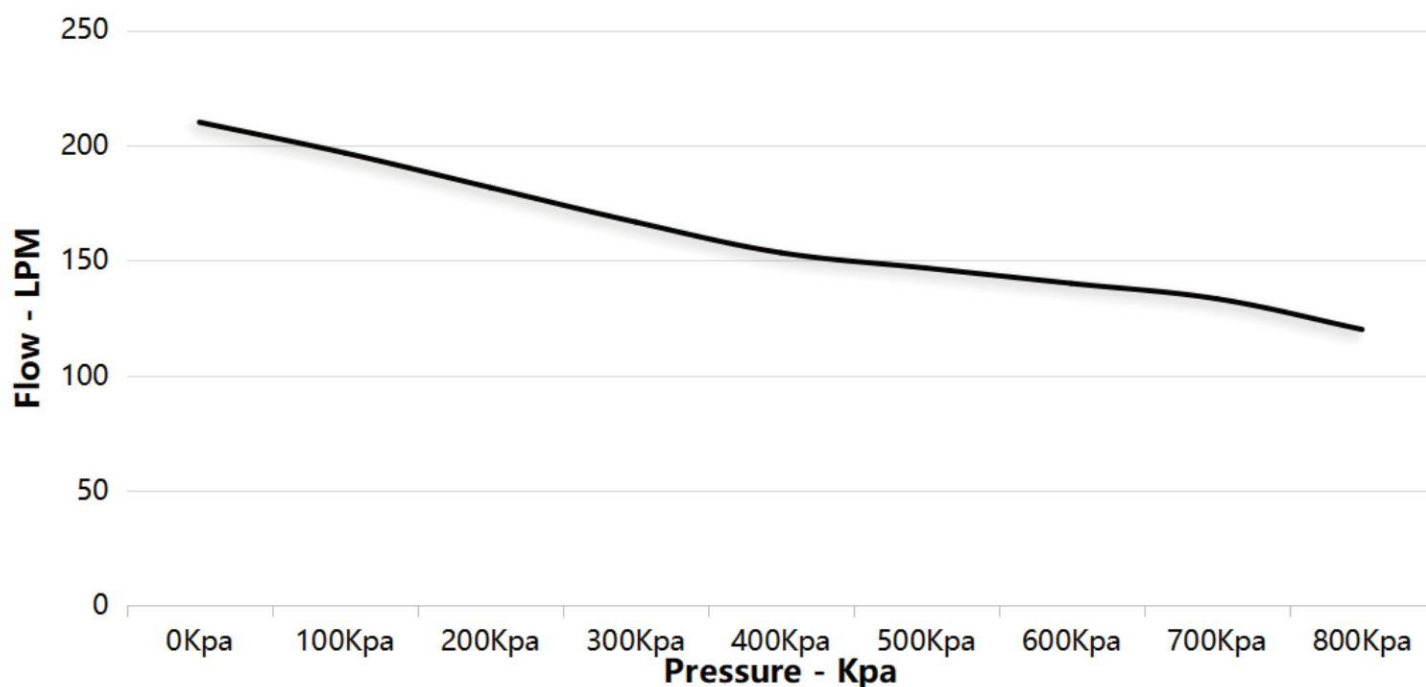

DC Oil Free Air Compressor



Technical Specification

Model	HC480C-24L	HC480D-24L	HC480E-24L
Voltage	DC12V	DC24V	DC48V
Current at rated pressure	46.66 A	23.33 A	11.66 A
Power at rated pressure	≤560W	≤560W	≤560W
Air flow rate at rated pressure	45 L/min @ 700Kpa	45 L/min @ 700Kpa	45 L/min @ 700Kpa
Dimension	520*230*580 mm	520*230*580 mm	520*230*580 mm
Rated speed	1700rpm	1700rpm	1700rpm
Net weight	20 kg	20 kg	20 kg
Noise	≤65dB(A)	≤65dB(A)	≤65dB(A)

Performance Chart - Flow VS. Pressure

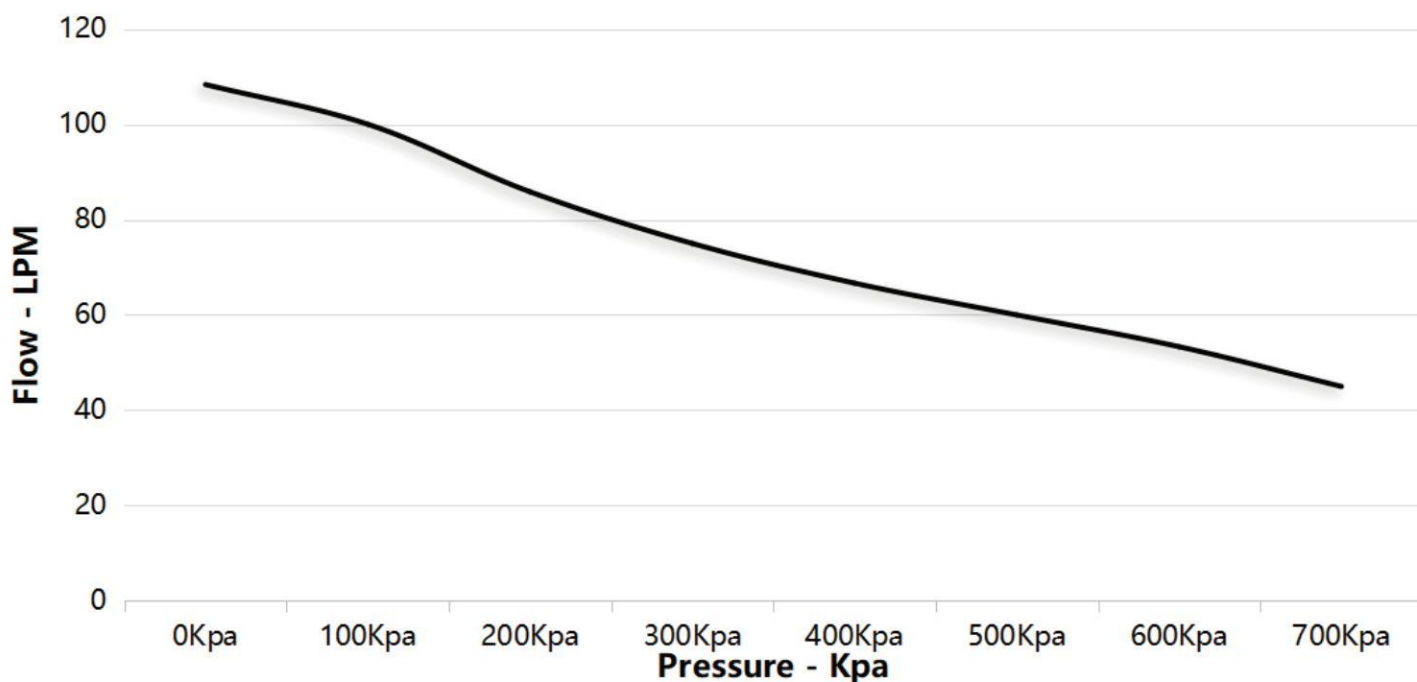

Accessories

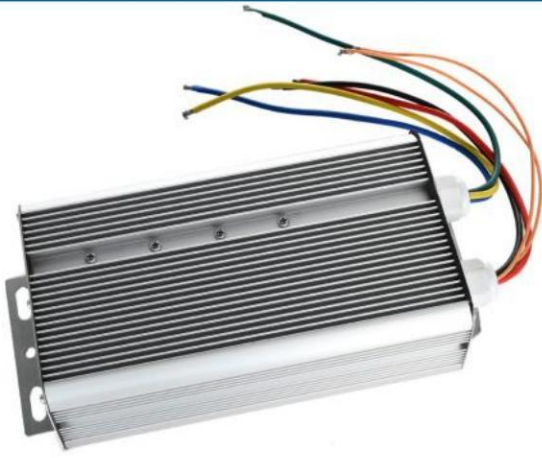

Controller



Cylinder



Silencer



Foot pad



Piston Ring



Fan and cover

HCEM • 浙江鸿川动力

HONGCHUAN POWER TECHNOLOGY CO.,LTD



web



alibaba web



 YouTube

Tell:0579-85395979 Fax:0579-85395960

Address: No. 636 Guangshun Street, Xiaoshun Town, Jindong District, Jinhua City, Zhejiang Province, China, 321036